

GP-A SERIES

High Accuracy Eddy Current Type Displacement Sensor



High accuracy analog sensing of minute displacement

Accurate measurement of minute displacements

Minute displacement of metallic objects can be accurately measured with a resolution of 0.04 % F.S.

[GP-A5S (For 1 mm 0.039 in sensing type)]
Resolution: 0.4 μm 0.016 mil

The sensor head protected as per IP67g (JEM)

With IP67g environment resistance, variegated measurements are rendered possible under many different conditions.

Sensors can be customized for metals other than steel

It is now possible to customize sensors to meet your metal measurement requirements.

(Performance may vary depending on conditions. Please contact our office.)

Linearity ± 0.5 % F.S.

Displacement is accurately output since it incorporates a high accuracy linearity correction circuit.

Sensor heads can be mounted in narrow spaces

If mounting standard types and different frequency types parallel to each other, they use up one-third the space needed for mounting compared to the same models. In addition, the GP-A14F type can be mounted close together and the sensor heads can be set in a narrow range for distortion and other difficult measurements.

Easy hookup connector type

Because the sensor heads and the amplifier are connected with a connector, they can be set up with one touch. This resolves the problem of measurements impaired by connection resistance fluctuations occurring with terminal types.

Stable temperature characteristics

These sensor heads boast a 2 mm 0.079 in or more sensing range enabling 0.03 % F.S./ $^{\circ}\text{C}$. (Excluding the different frequency type)

[GP-A8S (For 2 mm 0.079 in sensing type)]
Temperature characteristics: 0.6 μm / $^{\circ}\text{C}$
0.024 mil / $^{\circ}\text{C}$

Choice of sensor heads

You can choose from among 5 types of sensor heads depending on the mounting space available and the application. Also, their cable joints are equipped with a special protector that helps prevent the cable from severing as a result of bending or other mishap.

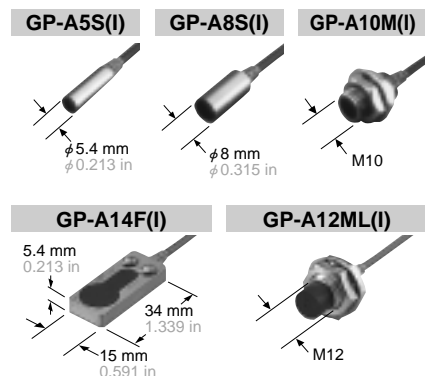

APPLICATIONS

Measuring iron sheet thickness

In combination with the digital panel controller **CA** series, it is optimally suited for measuring thickness of continuous iron sheets.

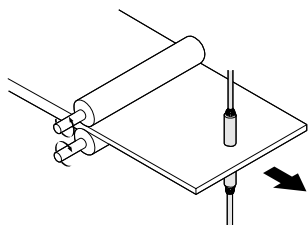

Measuring gap between rollers

Fine gap measurement is possible to control the gap between rollers.

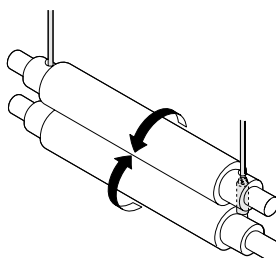

Measuring parallelism of chassis

Even a slight tilt can be reliably detected.

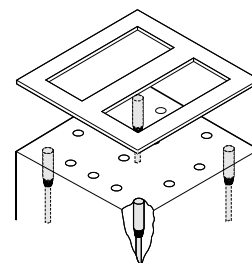

Equipped with a zero-adjustment function

By pressing the zero-adjustment button, you can reset the output voltage to 0 V with one touch. (Resets the current output to 4 mA)

This function comes in handy when performing tolerance diagnosis of a masterwork to be used as the standard. Easy adjustment for product changes. (Remote operation is also possible by way of an external input.)



Fine adjustment of output

Fine adjustment according to the sensing conditions is possible with shift and span functions.

Shift adjustment

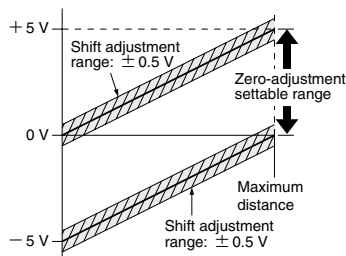

Span adjustment

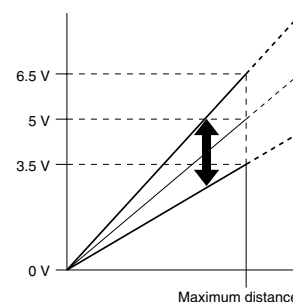

Equipped with useful indicators

The amplifier is equipped with an ALARM indicator (yellow), which lights up in case of sensor head cable disconnection or sensor head damage, and an OVER indicator (orange), which lights up in case the sensing range is exceeded.



Compact amplifier

The amplifier has a W53 × H90 × D67 mm W2.087 × H3.543 × D2.638 in compact size. Of course, it is mountable on a 35 mm 1.378 in width DIN rail.

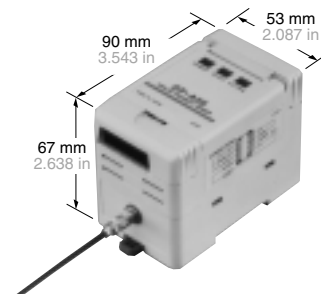

Suitable for various analog control devices

It is suitable for various analog control devices since it is equipped with two outputs, analog voltage (0 to 5 V) and analog current (4 to 20 mA).

Light / Reflective Type
LM10 HL-C1

LM10 HL-T1

Light / Thru-beam Type
LA-300 LA

LD

Magnetic Displacement
GP-X

GP-A

ORDER GUIDE

Please ensure to order the sensor head and the amplifier as a set. The set is calibrated and delivered.

Type	Appearance (mm in)		Sensing range	Set model No.	Output
	Sensor heads	Amplifier			
For 1 mm 0.039 in sensing Non-threaded type sensor head Different frequency				GP-A5S	Analog voltage • Output voltage: 1 to 5 V Analog current • Output current: 4 to 20 mA
				GP-A5SI	
For 2 mm 0.079 in sensing Non-threaded type sensor head Different frequency				GP-A8S	
				GP-A8SI	
For 2 mm 0.079 in sensing Threaded type sensor head Different frequency				GP-A10M	
				GP-A10MI	
For 5 mm 0.197 in sensing Threaded type sensor head Different frequency				GP-A12ML	
				GP-A12MLI	
For 3 mm 0.118 in sensing Front sensing type sensor head Different frequency				GP-A14F	
				GP-A14FI	

OPTIONS

Type	Model No.	Description
Sensor head mounting bracket	MS-SS5	Mounting bracket for GP-A5S(I)
	MS-SS8	Mounting bracket for GP-A8S(I)
Digital panel controller (Note)	CA2-T1	NPN open-collector transistor This is a very small controller which allows two independent threshold level settings. • Supply voltage: 24 V DC ± 10 % • No. of inputs: 1 No. (sensor input) • Input range: 4 to 20 mA (CA2-T1) ± 5 V (CA2-T4) • Main functions: Threshold level setting function, zero-adjust function, scale setting function, hysteresis setting function, start / hold function, auto-reference function, power supply ON-delay function, etc.
	CA2-T4	NPN open-collector transistor
	CA-R1	Relay-contact
	CA-R4	Relay-contact
	CA-T1	NPN open-collector transistor
	CA-T4	NPN open-collector transistor
	CA-B1	NPN open-collector transistor
CA-B4	NPN open-collector transistor With BCD output	This is a multi-functional controller having mathematical functions, hold function, etc. • Supply voltage: 100 to 240 V AC ± 10 % • No. of inputs: 2 Nos. (sensor inputs) • Input range: 4 to 20 mA (CA-□1) ± 5 V (CA-□4) • Power supply for sensor: 12 V DC, 150 mA • Main functions: Mathematical functions, process number selection function, hold function, scaling function, auto-reference function, power supply ON-delay function, measurement start delay function, hysteresis setting function, etc.

Sensor head mounting bracket

- MS-SS5
- MS-SS8

It enables easy fixing of the sensor head.

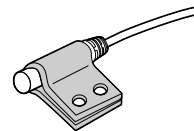

Digital panel controller

- CA2 series



- CA series



Note: For further details, refer to p.864~ for the ultra-compact digital panel controller CA2 series, and to p.854~ for the digital panel controller CA series.

SPECIFICATIONS

Item	Set model No.	For 1 mm 0.039 in sensing		For 2 mm 0.079 in sensing				For 5 mm 0.197 in sensing		For 3 mm 0.118 in sensing	
		Non-threaded type sensor head		Non-threaded type sensor head		Threaded type sensor head		Threaded type sensor head		Front sensing type sensor head	
		Different frequency		Different frequency		Different frequency		Different frequency		Different frequency	
		GP-A5S	GP-A5SI	GP-A8S	GP-A8SI	GP-A10M	GP-A10MI	GP-A12ML	GP-A12MLI	GP-A14F	GP-A14FI
Sensing range		0 to 1 mm 0.039 in		0 to 2 mm 0.079 in				0 to 5 mm 0.197 in		0 to 3 mm 0.118 in	
Standard sensing object		Iron sheet 8×8×t 1 mm 0.315×0.315×t 0.039 in		Iron sheet 12×12×t 1 mm 0.472×0.472×t 0.039 in				Iron sheet 30×30×t 1 mm 1.181×1.181×t 0.039 in		Iron sheet 15×15×t 1 mm 0.591×0.591×t 0.039 in	
Supply voltage		24 V DC ± 10 % Ripple P-P 10 % or less									
Current consumption		150 mA or less									
Analog output (Analog voltage output) (Analog current output)		Analog voltage • Output voltage: 0 to 5 V • Output impedance: 100 Ω approx.					Analog current • Output current: 4 to 20 mA • Load resistance: 0 to 350 Ω				
Response frequency		1.6 kHz (− 3 dB)									
Resolution		0.04 % F.S.									
Linearity		Within ± 0.5 % F.S.									
Alarm output		NPN open-collector transistor • Maximum sink current: 100 mA • Applied voltage: 30 V DC or less (between alarm output and 0 V) • Residual voltage: 1.6 V or less (at 100 mA sink current) 0.4 V or less (at 16 mA sink current)									
Output operation		Turns ON when the sensor head connection is improper or the sensor head cable is disconnected.									
Short-circuit protection		—									
External zero-adjustment input		Input condition: Non-voltage contact or NPN open-collector transistor input Signal condition: Low ... 0 to 1 V (duration 30 ms or more) High ... 5 to 30 V, or open Operation: Low ... External zero-adjustment setting High ... External zero-adjustment ineffective									
Zero-adjustment setting method		Push button setting / External input setting									
Power indicator		Green LED (lights up when the power is ON)									
Over indicator		Orange LED (lights up when sensing range is exceeded)									
Alarm indicator		Yellow LED (lights up when the alarm output is ON)									
Adjustments		① Shift adjustment (by push-buttons), ② Span adjustment (by 14-turn adjuster)									
Temperature characteristics (Note 1)	Sensor head	0.5 μm /°C 0.020 mil /°C	0.6 μm /°C 0.024 mil /°C	1 μm /°C 0.039 mil /°C	0.6 μm /°C 0.024 mil /°C	1 μm /°C 0.039 mil /°C	1.5 μm /°C 0.059 mil /°C	2.5 μm /°C 0.098 mil /°C	0.9 μm /°C 0.035 mil /°C	1.5 μm /°C 0.059 mil /°C	
	Amplifier	0.4 μm /°C 0.016 mil /°C		0.8 μm /°C 0.031 mil /°C				2.0 μm /°C 0.079 mil /°C		1.2 μm /°C 0.047 mil /°C	
Protection	Sensor head	IP67 (IEC), IP67 g (JEM)									
	Amplifier	—									
Ambient temperature	Sensor head	− 10 to + 55 °C + 14 to + 131 °F, Storage: − 20 to + 70 °C − 4 to + 158 °F									
	Amplifier	0 to + 50 °C + 32 to + 122 °F (No dew condensation), Storage: 0 to + 50 °C + 32 to + 122 °F									
Ambient humidity		35 to 85 % RH, Storage: 35 to 85 % RH									
Voltage withstandability	Sensor head	250 V AC for one min. between all supply terminals connected together and enclosure									
Insulation resistance	Sensor head	20 MΩ, or more, with 250 V DC megger between all supply terminals connected together and enclosure									
Vibration resistance	Sensor head	10 to 55 Hz frequency, 1.5 mm 0.059 in amplitude in X, Y and Z directions for two hours each									
	Amplifier	10 to 150 Hz frequency, 0.75 mm 0.030 in amplitude in X, Y and Z directions for two hours each									
Shock resistance	Sensor head	500 m/s ² acceleration (50 G approx.) in X, Y and Z directions for five times each									
	Amplifier	100 m/s ² acceleration (10 G approx.) in X, Y and Z directions for five times each									
Material	Sensor head	Enclosure: Stainless steel (SUS303) Sensing part: Polyallylate			Enclosure: Stainless steel (SUS303) Sensing part: ABS			Enclosure: Brass (Nickel plated) Sensing part: Nylon		Enclosure: Stainless steel (SUS303) Sensing part: ABS	
	Amplifier	Enclosure: ABS									
Cable	Sensor head	Connector attached high frequency coaxial cable, 3 m 9.843 ft long									
Cable length (Note 2)	Amplifier	Up to total 100 m 328.084 ft with 0.3 mm ² , or more, cable									
Weight	Sensor head	40 g approx.				50 g approx. (Note 3)		45 g approx. (Note 3)		50 g approx.	
	Amplifier	170 g approx.									
Accessories		Adjusting screwdriver: 1 pc.				Nut: 2 pcs., Toothed lock washer: 1 pc. Adjusting screwdriver: 1 pc.				2 pcs. each of M3 countersunk head screws, spring washers, plain washers and M3 nuts Adjusting screwdriver: 1 pc.	

Notes: 1) These values are for a range which is 20 to 60 % of the maximum sensing distance.
2) Take care that the output voltage is reduced due to the resistance of the wiring cable.
3) The given weight of the threaded type sensor head is the value including the weight of the nuts and the toothed lock washer.

HL-C1

Light / Reflective Type

LM10

HL-T1

LA-300

LA

LD

GP-X

GP-A

Magnetic Displacement

GP-A

GP-A

GP-A

GP-A

GP-A

GP-A

GP-A

GP-A

GP-A

GP-A

GP-A

GP-A

GP-A

GP-A

I/O CIRCUIT AND WIRING DIAGRAMS

I/O circuit diagram

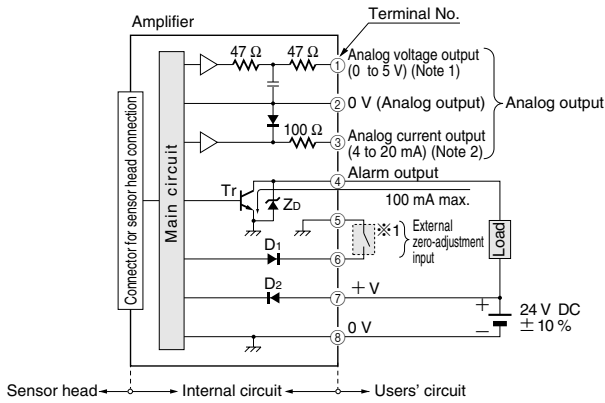

- Notes: 1) In case of using the analog voltage output, connect a device having a high input impedance. Also, take care that the output voltage is reduced due to the resistance of the wiring cable.
 2) The alarm output is not incorporated with a short-circuit protection circuit. Do not connect it directly to a power supply or a capacitive load.

Symbols ... D1: Input protection diode
 D2: Reverse supply polarity protection diode
 Z_D: Surge absorption zener diode
 Tr: NPN output transistor

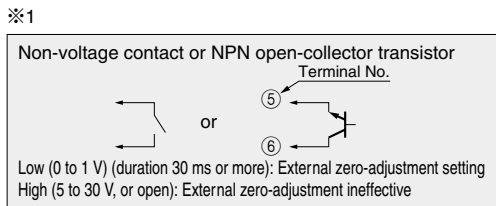

Wiring diagram

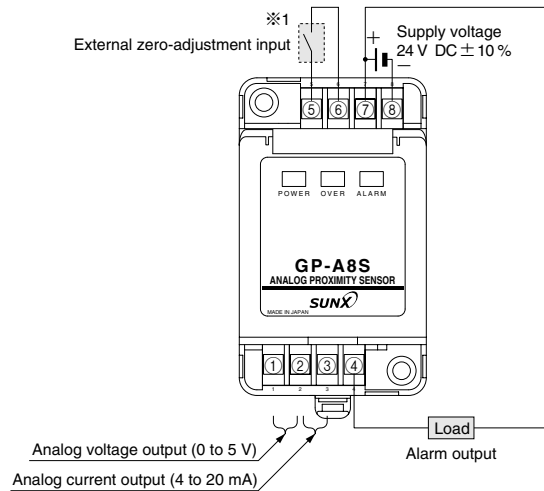

Note: After the wiring, make sure to fit the terminal covers. The terminal cover having a concave depression at the top should be fitted on the side having terminal Nos. 1 to 4.

SENSING CHARACTERISTICS (TYPICAL)

Correlation between material and output voltage / current

The GP-A series is made for all types of standard iron sensing objects. The graph below describes the output discrepancies that occur when detecting different types of metals. It is now possible to customize sensors to meet your metal measurement requirements. For more details, please contact our office.

GP-A5S(I)

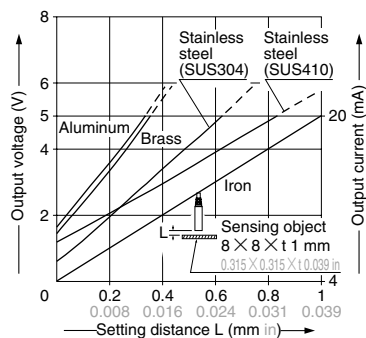

GP-A8S(I)
GP-A10M(I)

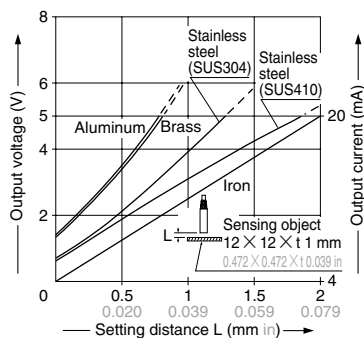

SENSING CHARACTERISTICS (TYPICAL)

Correlation between material and output voltage / current

GP-A12ML(I)

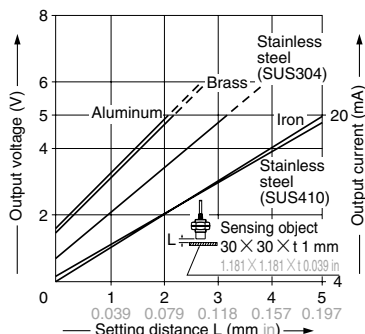

GP-A14F(I)

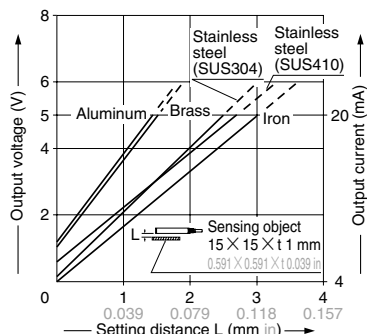

PRECAUTIONS FOR PROPER USE



This product is not a safety sensor. Its use is not intended or designed to protect life and prevent body injury or property damage from dangerous parts of machinery. It is a normal object detection sensor.

- Make sure to use in combination the sensor head and amplifier which have the same production serial number (5 digit). Since adjustment is done before shipment, if items with different production serial numbers are combined, the sensing characteristics will deteriorate even if they have the same model number.
- The length of the sensor head cable cannot be changed.

Linearity in case of disc-shaped or cylindrical objects

- In case the sensing object is disc-shaped or cylindrical, the linearity of the analog output varies with the sensing object size. In such a case, conduct zero adjustment when close mounting and, by adjusting to the maximum sensing distance and to 5 V as the voltage output (current output 20 mA), linearity ($\pm 0.5\%$ F.S.) can be attained on a full-scale if the sensing object's size is larger than those described in the table below.

Model No.	Iron disc diameter ϕ (mm in)	Iron cylinder diameter ϕ (mm in)
GP-A5S(I)	12 0.472	10 0.394
GP-A8S(I)	12 0.472	10 0.394
GP-A10M(I)	12 0.472	10 0.394
GP-A12ML(I)	30 1.118	50 1.969
GP-A14F(I)	12 0.472	10 0.394

<In case of disc>

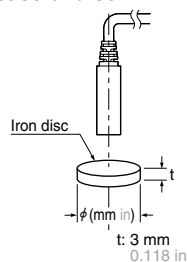

<In case of cylinder>

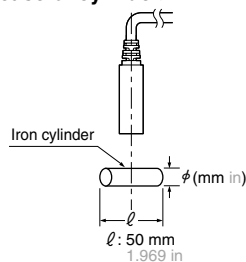

Mounting sensor head

- The tightening torque should be under the value given below.

Mounting with set screw

- Make sure to use an M3 or smaller set screw having a cup-point.

<Non-threaded type Sensor head>

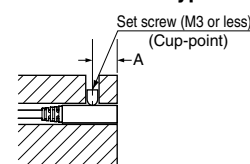

Model No.	A (mm in)	Tightening torque
GP-A5S(I)	5 0.197	0.44 N·m
GP-A8S(I)	or more	0.58 N·m

Note: Do not apply excess torque.

Mounting with nut

<Threaded type Sensor head>

GP-A10M(I) GP-A12ML(I)

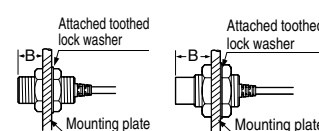

Model No.	B part (mm in)	Tightening torque
GP-A10M(I)	7 0.276	9.8 N·m
GP-A12ML(I)	14 0.551	20 N·m

Note: Install in such a way so that the nut does not protrude from the screw.

Mounting GP-A14F(I)

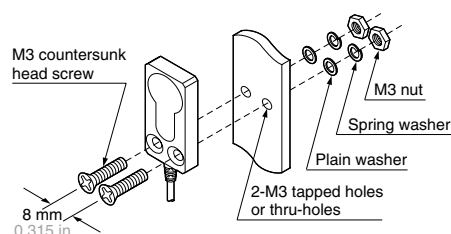

GP-A

PRECAUTIONS FOR PROPER USE

Distance from surrounding metal

- As metal around the sensor may affect the sensing performance, pay attention to the following points.

<Embedding of the sensor in metal>

- Since the analog output may change if the sensor is completely embedded in metal, keep the minimum distance specified in the table below. **GP-A14F(I)** can be used by being completely embedded in metal. However, the surrounding metal should not protrude beyond the sensing face.

<Non-threaded type sensor head threaded type sensor head>

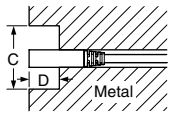

<Front sensing type sensor head>

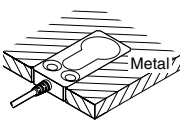

Model No.	C (mm in)	D (mm in)
GP-A5S(I)	φ 18 φ 0.709	4 0.157
GP-A8S(I)		7 0.276
GP-A10M(I)	φ 50 φ 1.969	14 0.551
GP-A12ML(I)		14 0.551

Mutual interference

- When two or more sensors are installed in parallel or face to face, since the specifications may not be met, keep the minimum separation distance specified in the table below.

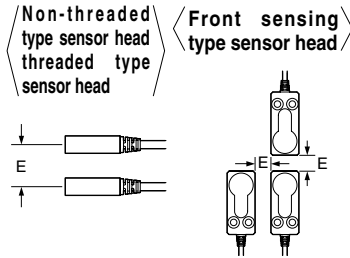

Model No.	E (mm in)	
	Between 'I' type and non-'I' type	Between two 'I' types or two non-'I' types
GP-A5S(I)	11 0.433	36 1.417
GP-A8S(I) GP-A10M(I)	11 0.433	38 1.496
GP-A12ML(I)	14 0.551	130 5.118
GP-A14F(I)	0 0	30 1.181

- Notes: 1) 'I' type is different frequency type.
2) If the required resolution is lower than the specification (0.04 % F.S.), it is possible to bring the sensor heads nearer than the separation distances given in the table above. For further details, please contact our office.

Mounting amplifier

Mounting on DIN rail

- With the stopper pressed in the direction of the arrow (it locks), fit the front portion of the mounting section of the amplifier on the 35 mm 1.378 in width DIN rail.

(Lightly press the grooved section of the stopper downwards when pressing the stopper in.)

- Press and fit the rear portion of the mounting section on the 35 mm 1.378 in width DIN rail.

- To remove, insert a 'minus' screwdriver into the stopper and pull out.

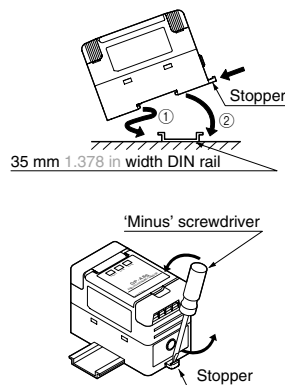

Mounting with screws

- Use two commercially available M4 pan head screws (length 10 mm 0.394 in or more). The tightening torque should be 1.2 N·m or less. Please arrange the pan head screws and nuts separately. The mounting holes for the screws can be accessed by removing the terminal cover. To remove the terminal cover, insert a 'minus' screwdriver into the groove of the terminal cover and lift up.

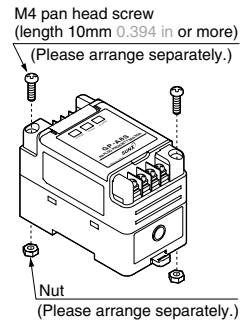

- Notes: 1) If two, or more, amplifiers are mounted together, make sure to leave a gap of at least 10 mm 0.394 in between them.
2) If the amplifier is installed in a control box, etc., ensure proper ventilation.

Connection of sensor head and amplifier

- Hold the sensor head's connector by the outer ring and insert it into the connector provided on the amplifier for sensor head connection. Insert till you hear a click sound.

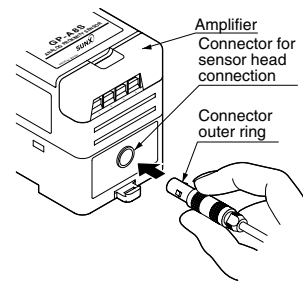

- To remove the sensor head, hold its connector by the outer ring and pull it straight out.

- Note: Do not pull by holding the cable, as this can result in cable disconnection.

Dimensions of suitable crimp terminals (Unit: mm in)

Y type	Round type
(After crimping)	(After crimping)

- Note: Please use crimp terminals which have insulation sleeves.
Recommended crimp terminal: Type 1.25 – 3.0

Wiring

- Make sure that the power supply is off while wiring.
- Verify that the supply voltage variation is within the rating.
- If power is supplied from a commercial switching regulator, ensure that the frame ground (F.G.) terminal of the power supply is connected to an actual ground.
- In case noise generating equipment (switching regulator, inverter motor, etc.) is used in the vicinity of the sensor head or the amplifier, connect the frame ground (F.G.) terminal of the equipment to an actual ground.
- Do not run the wires together with high-voltage lines or power lines or put them in the same raceway. This can cause malfunction due to induction.

PRECAUTIONS FOR PROPER USE

Functional description

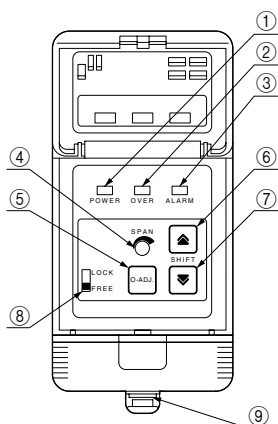

※Cover opened condition

	Description	Function	
①	Power indicator (Green)	Lights up when the power is ON.	
②	Over indicator (Orange)	Lights up when the sensing range is exceeded.	
③	Alarm indicator (Yellow)	Lights up when the sensor head connection is improper or the sensor head cable is disconnected.	
④	Span adjuster	Analog output's output voltage range and output current range can be adjusted. It is a 14-turn potentiometer.	
⑤	Zero-adjustment button	The zero-point of the analog output can be set. Further, if it is pressed continuously for 3 sec., or more, the zero-point value can be erased.	
⑥	Shift-up button	Analog output's offset value can be increased.	If both the buttons are pressed simultaneously for 3 sec., or more, the set value can be erased.
⑦	Shift-down button	Analog output's offset value can be decreased.	
⑧	Button operation effective / ineffective selection switch	If it is set to the 'LOCK' side, the operation of the zero-adjustment button, the shift-up button and the shift-down button is ineffective. Set it to the 'FREE' side during adjustment, and to the 'LOCK' side during sensing. The values of zero-point setting and shift adjustment are stored in an EEPROM (memory) whenever the switch is changed from the 'FREE' side to the 'LOCK' side.	
⑨	Connector for sensor head connection	It is the connector for sensor head connection.	

Alarm output

- It is output when the sensor head connection is improper or the sensor head cable is disconnected.
- The alarm output is not incorporated with a short-circuit protection circuit. Do not connect it directly to a power supply or a capacitive load.

External zero-adjustment input

- The external zero-adjustment input should be applied 30 min., or more, after the power supply is switched on.
- Zero-adjustment can be remotely done by an external input by using the zero-adjustment input terminals (terminal Nos. 5 and 6).
- If the external zero-adjustment input terminals (terminal Nos. 5 and 6) are short-circuited for 30 ms, or more, the analog voltage output and the analog current output are forcibly set to 0 V and 4 mA, respectively.

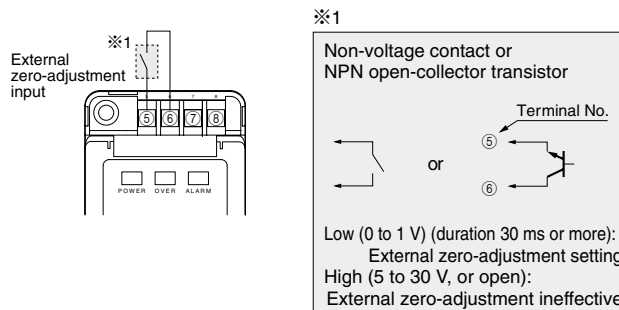

- The external zero-adjustment input operation is independent of the state of the 'button operation effective / ineffective selection switch'. However, since the external zero-adjustment setting is not stored in the EEPROM (memory), it is canceled when the power supply is switched off. In case it is desired to store the setting in the EEPROM, set the 'button operation effective / ineffective selection switch' once to the 'FREE' side and again to the 'LOCK' side, before switching off the power supply.

Note: If the power supply is switched on with the external zero-adjustment input terminals (terminal Nos. 5 and 6) short-circuited, since zero-adjustment gets done in the transient state of the power supply switching on, stable sensing is not possible. Further, ensure to apply the zero-adjustment input 30 min., or more, after the power supply is switched on.

Others

- Do not use during the initial transient time (0.5 sec.) after the power supply is switched on.
- Do not use the sensor at places having intense vibrations, as this can cause malfunction.
- Avoid dust, dirt, and steam.
- Take care that the product does not come in direct contact with water, oil, grease, or organic solvents, such as, thinner, etc.
- Take care that the sensing face is not covered with metal dust, scrap, or spatter etc., as this can cause malfunction.

PRECAUTIONS FOR PROPER USE

Adjustment

• This product is delivered after being adjusted with the standard sensing object. However, since there is some difference due to the sensing object being used, carry out the adjustment as per the following procedure, using a voltmeter or ammeter, oscilloscope, etc.

① Switch on the power supply after confirming that proper connection has been made to the external device to which **GP-A** is to be connected.

② Start the adjustment 30 min., or more, after switching on the power supply.

③ Open the cover on the top of the amplifier and set the 'button operation effective / ineffective selection switch' to the 'FREE' side.

Button operation effective / ineffective selection switch.



④ Touching the sensor head to the sensing object, press the 'zero-adjustment button' and set the zero-point. At this time, the analog voltage output and the analog current output are forcibly set to 0 V and 4 mA, respectively.

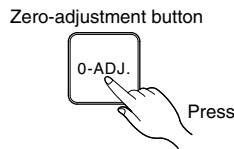
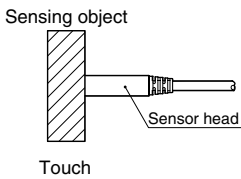

⑤ Set the sensor head at the maximum distance [**GP-A5S(I)**: 1 mm 0.039 in, **GP-A8S(I)** and **GP-A10M(I)**: 2 mm 0.079 in, **GP-A12ML(I)**: 5 mm 0.197 in and **GP-A14F(I)**: 3 mm 0.118 in] from the sensing object. At this time, adjust the analog voltage output to +5 V or the analog current output to 20 mA with the 'span adjuster'.

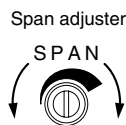
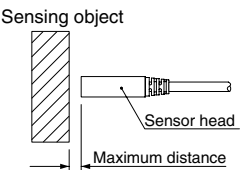

Note: Since the analog voltage output and the analog current output get adjusted simultaneously, it is not possible to adjust them individually.

⑥ Once again, touch the sensor head to the sensing object, and confirm that the analog voltage output and the analog current output are 0 V and 4 mA, respectively. In case they are not, repeat the adjustment from step ④.

⑦ The following shift adjustment and span adjustment can be done if required.

Shift adjustment range

<Analog voltage output>

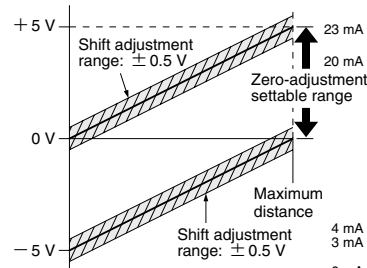

<Analog current output>

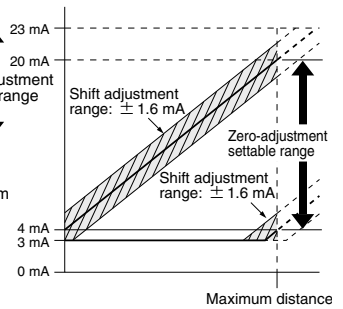

• Using the 'shift-up button' and the 'shift-down button', it is possible to adjust the offset value for the analog voltage output by ± 0.5 V and that for the analog current output by ± 1.6 mA.

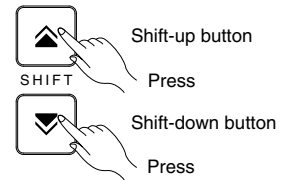

• As long as the sensing object is within the sensing range, the analog voltage output and the analog current output can be adjusted to 0 V and 4 mA, respectively, with the 'zero-adjustment button'.

Note: The analog current output is limited to a lower limit of 3 mA and an upper limit of 23 mA by a control circuit.

Span adjustment range

• The output span (slope) can be adjusted with the 'span adjuster' over a range of 0.7 to 1.3 times than that for the standard sensing object.

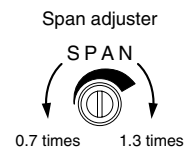
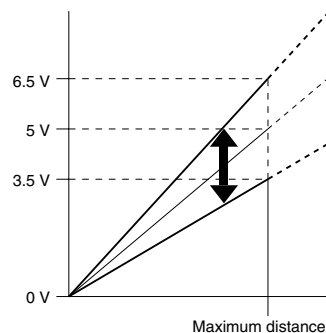

Note: Since the span adjustment can be done irrespective of the 'button operation effective / ineffective selection switch' position, do not operate the span adjuster after the adjustment.

⑧ After the adjustment, make sure to set the 'button operation effective / ineffective selection switch' to the 'LOCK' side and close the cover on top of the amplifier.

Button operation effective / ineffective selection switch



• The values of zero-point setting and shift adjustment get stored in an EEPROM when the switch is set to the 'LOCK' side. The values stored in the EEPROM are not erased even when the power supply is switched off. However, kindly note that the EEPROM has a life span and its guaranteed life is 100,000 write operation cycles.

Notes: 1) The set values are not stored in the EEPROM if the power supply is switched off when the switch is on the 'FREE' side.
2) If the switch is set to the 'LOCK' side before adjustment, the set values cannot be changed.

DIMENSIONS (Unit: mm in) The CAD data in the dimensions can be downloaded from the SUNX website: <http://www.sunx.co.jp/>

Sensor head

GP-A5S(I)

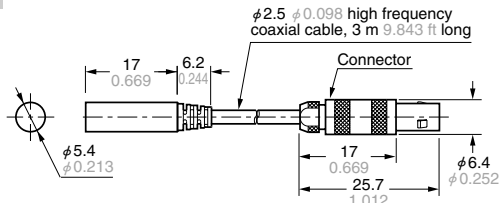

GP-A8S(I)

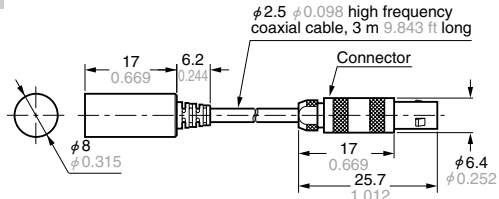

GP-A10M(I)

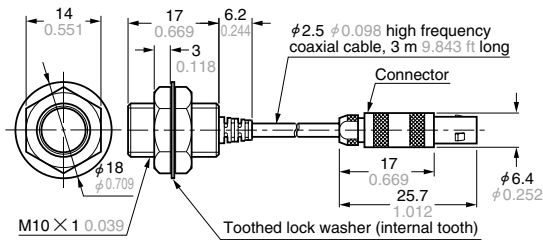

GP-A12ML(I)

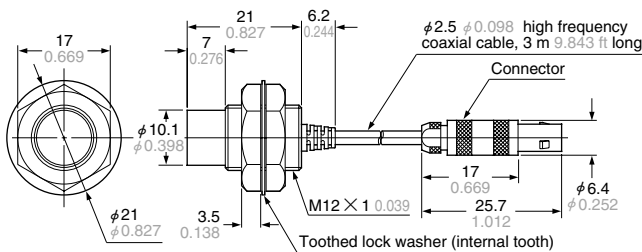

GP-A14F(I)

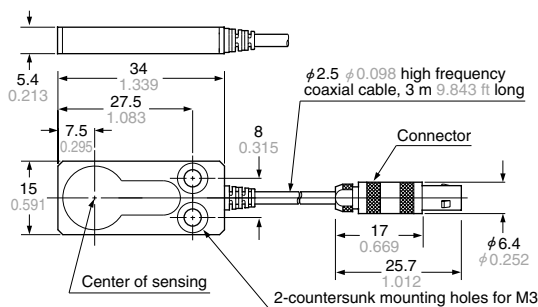

Amplifier

All models

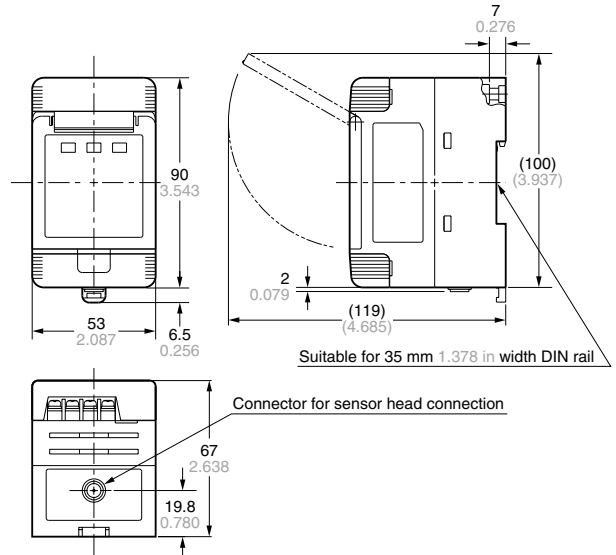

Cover removed condition

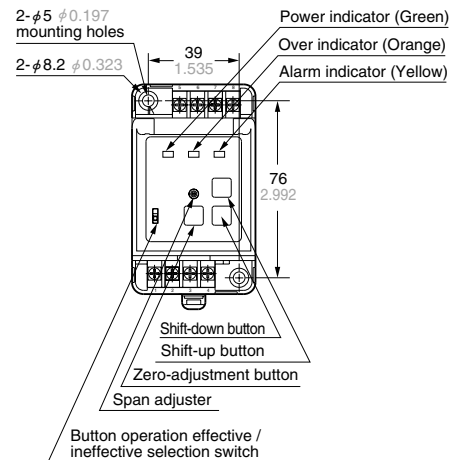

MS-SS5 MS-SS8

Mounting bracket for GP-A5S(I) (Optional), mounting bracket for GP-A8S(I) (Optional)

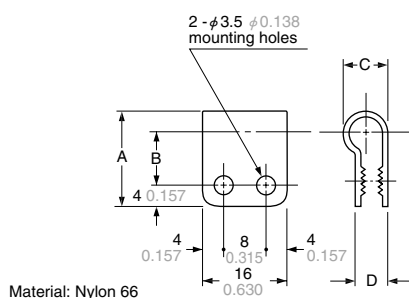

Material: Nylon 66

Item	Model No.	MS-SS5	MS-SS8
A		18 0.709	20 0.787
B		10 0.394	11 0.433
C		8.3 0.327	10.3 0.406
D		6.1 0.240	6.5 0.256
Applicable model		GP-A5S(I)	GP-A8S(I)

Light / Reflective Type
HL-C1
LH-50
LM10
HL-T1
LA-300
LA
LD

Magnetic Displacement
GP-X
GP-A