

RX-LS200

Adjustable Range & Fixed-focus Reflective Photoelectric Sensor **Amplifier Built-in**

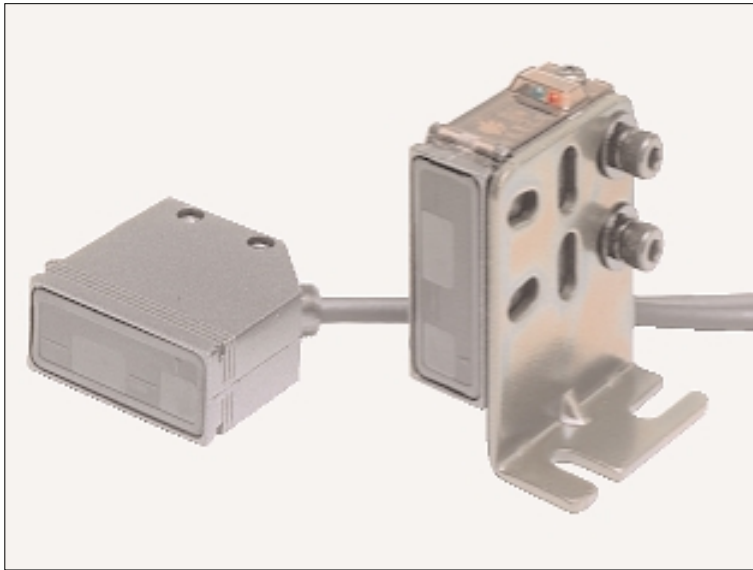

Detection of different color objects at a certain distance



Not affected by color

The color or size of the object does not affect its sensing.

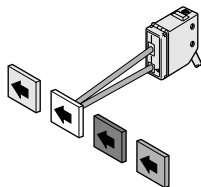

Not affected by background

The sensor does not detect the background beyond the set distance since it is distance settable type.

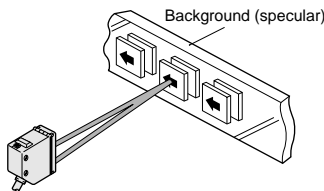

Insusceptible to dust

The sensing performance is less affected by dust as it does not depend on the incident light intensity.

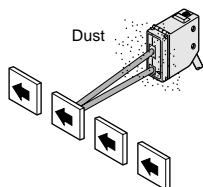

Waterproof

The sensor can be hosed down because of its IP67 construction. The equipment on which the sensor is mounted can be washed without any problem.

Note: However, take care that if it is exposed to water splashes during operation, it may detect a water drop itself.

Robust

Its robust enclosure is made of die-cast zinc alloy.

High-speed response time: 1 ms

It can be used on a high speed assembly line.

Principle of Optical Sensing

Adjustable Range & Fixed-focus Reflective Type

The sensing range for which the sensor detects an object is determined by the incident beam angle, regardless of the incident light intensity.

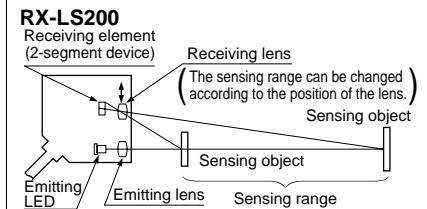

Convergent Reflective Type

The sensor detects an object only in the overlapping area of the emitting and receiving envelopes. The detectability is a little influenced by the reflectivity of the object surface.

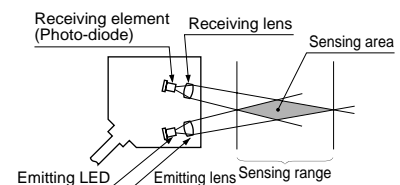

Diffuse Reflective Type

The sensing range changes with the reflectivity and size of the sensing object.

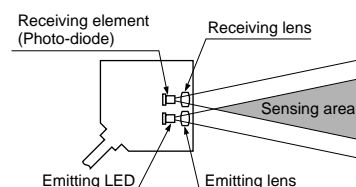

APPLICATIONS

Detecting lids of cups

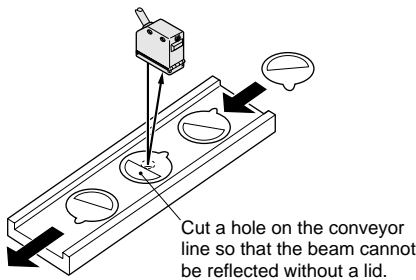

Safekeeping at parking garage

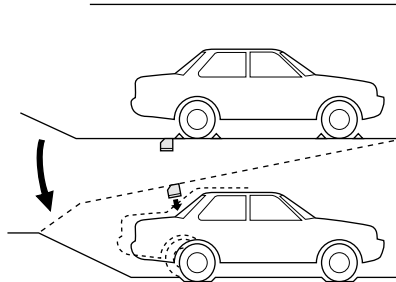

Wafer counting in cassette

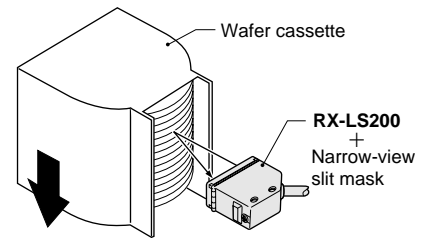

ORDER GUIDE

Type	Appearance	Sensing range	Model No.	Output
NPN output 5 m 16.404 ft cable length			RX-LS200	NPN open-collector transistor
			RX-LS200-C5	
PNP output			RX-LS200-P	PNP open-collector transistor

Accessory

- **MS-RX-1** (Sensor mounting bracket)

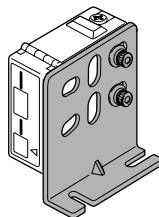

Two M4 (length 16 mm 0.630 in) hexagon-socket-head bolts are attached.

OPTIONS

Designation	Model No.	Description	
Narrow-view slit mask	OS-RXL-1	Slit size	The sensing view is narrowed laterally so that the effect of the object's surroundings is reduced.
	OS-RXL-2		
	OS-RXL-3		
Protective tube	PT-RX500	Length	Cable is protected from external forces. It does not rust as it is made of stainless steel.
	PT-RX1000		

Narrow-view slit mask

- **OS-RXL-□**

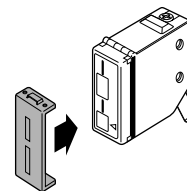

Protective tube

- **PT-RX500**
- **PT-RX1000**

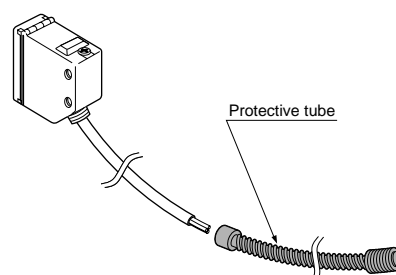

RX-LS200

SPECIFICATIONS

Item	Model No.	Adjustable range & fixed-focus reflective	
		NPN output type	PNP output type
		RX-LS200	RX-LS200-P
Sensing range		50 to 200 mm 1.969 to 7.874 in with white non-glossy paper (50 × 50 mm 1.969 × 1.969 in)	
Hysteresis		10 % or less of operation distance	
Repeatability		Along sensing axis: 1 mm 0.039 in or less, Perpendicular to sensing axis: 0.5 mm 0.020 in or less	
Supply voltage		12 to 24 V DC ± 10 % Ripple P-P 10 % or less	
Current consumption		40 mA or less	
Output		NPN open-collector transistor • Maximum sink current: 100 mA • Applied voltage: 30 V DC or less (between output and 0 V) • Residual voltage: 1.5 V or less (at 100 mA sink current) 0.4 V or less (at 16 mA sink current)	PNP open-collector transistor • Maximum source current: 100 mA • Applied voltage: 30 V DC or less (between output and + V) • Residual voltage: 1 V or less (at 100 mA source current) 0.4 V or less (at 16 mA source current)
	Utilization category	DC-12 or DC-13	
	Output operation	Switchable either Light-ON or Dark-ON	
	Short-circuit protection	Incorporated	
Response time		1 ms or less	
Operation indicator		Red LED (lights up when the output is ON)	
Stability indicator		Green LED (lights up under stable light received condition or stable dark condition)	
Distance adjuster		2-turn mechanical adjuster	
Environmental resistance	Pollution degree	3 (Industrial environment)	
	Protection	IP67 (IEC)	
	Ambient temperature	- 25 to + 60 °C - 13 to + 140 °F (No dew condensation or icing allowed), Storage: - 30 to + 70 °C - 22 to + 158 °F	
	Ambient humidity	35 to 85 % RH, Storage: 35 to 85 % RH	
	Ambient illuminance	Sunlight: 11,000 lx at the light-receiving face, Incandescent light: 3,500 lx at the light-receiving face	
	EMC	EN 50081-2, EN 50082-2, EN 60947-5-2	
	Voltage withstandability	1,000 V AC for one min. between all supply terminals connected together and enclosure	
	Insulation resistance	20 MΩ, or more, with 250 V DC megger between all supply terminals connected together and enclosure	
	Vibration resistance	10 to 500 Hz frequency, 1.5 mm 0.059 in amplitude (10 G max.) in X, Y and Z directions for two hours each	
Shock resistance	500 m/s ² acceleration (approx. 50 G) in X, Y and Z directions for three times each		
Emitting element		Infrared LED (modulated)	
Material		Enclosure: Die-cast zinc alloy, Indicator cover: Polyethersulphone, Lens: Polycarbonate	
Cable		0.15 mm ² 3-core oil, heat and cold resistant cabtyre cable, 3 m 9.843 ft long	
Cable extension		Extension up to total 100 m 328.084 ft is possible with 0.3 mm ² , or more, cable.	
Weight		85 g approx.	
Accessories		MS-RX-1 (Sensor mounting bracket): 1 set, Adjusting screwdriver: 1 pc.	

I/O CIRCUIT AND WIRING DIAGRAMS

NPN output type

I/O circuit diagram

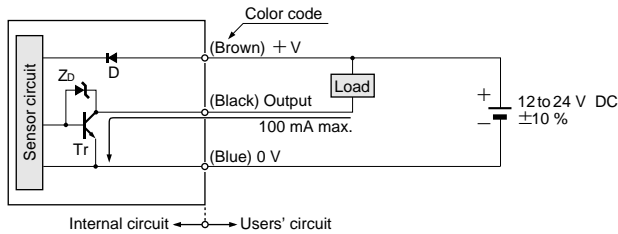

Symbols ... D : Reverse supply polarity protection diode
Zb: Surge absorption zener diode
Tr: NPN output transistor

Wiring diagram

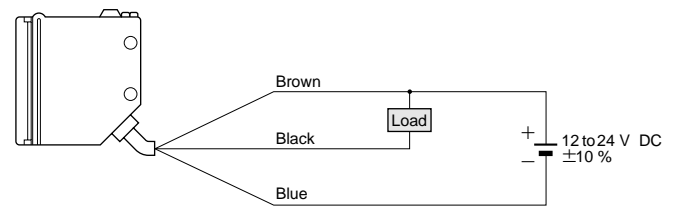

PNP output type

I/O circuit diagrams

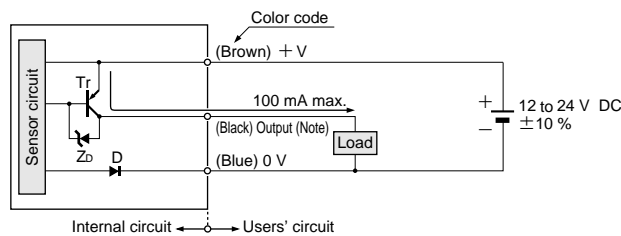

Note: The output does not incorporate a short-circuit protection circuit.
Do not connect it directly to a power supply or a capacitive load.

Symbols ... D : Reverse supply polarity protection diode
Zb: Surge absorption zener diode
Tr: PNP output transistor

Wiring diagram

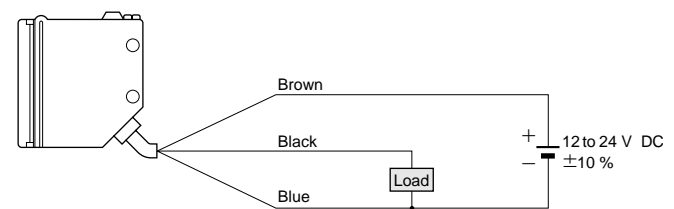

SENSING CHARACTERISTICS (TYPICAL)

Sensing fields

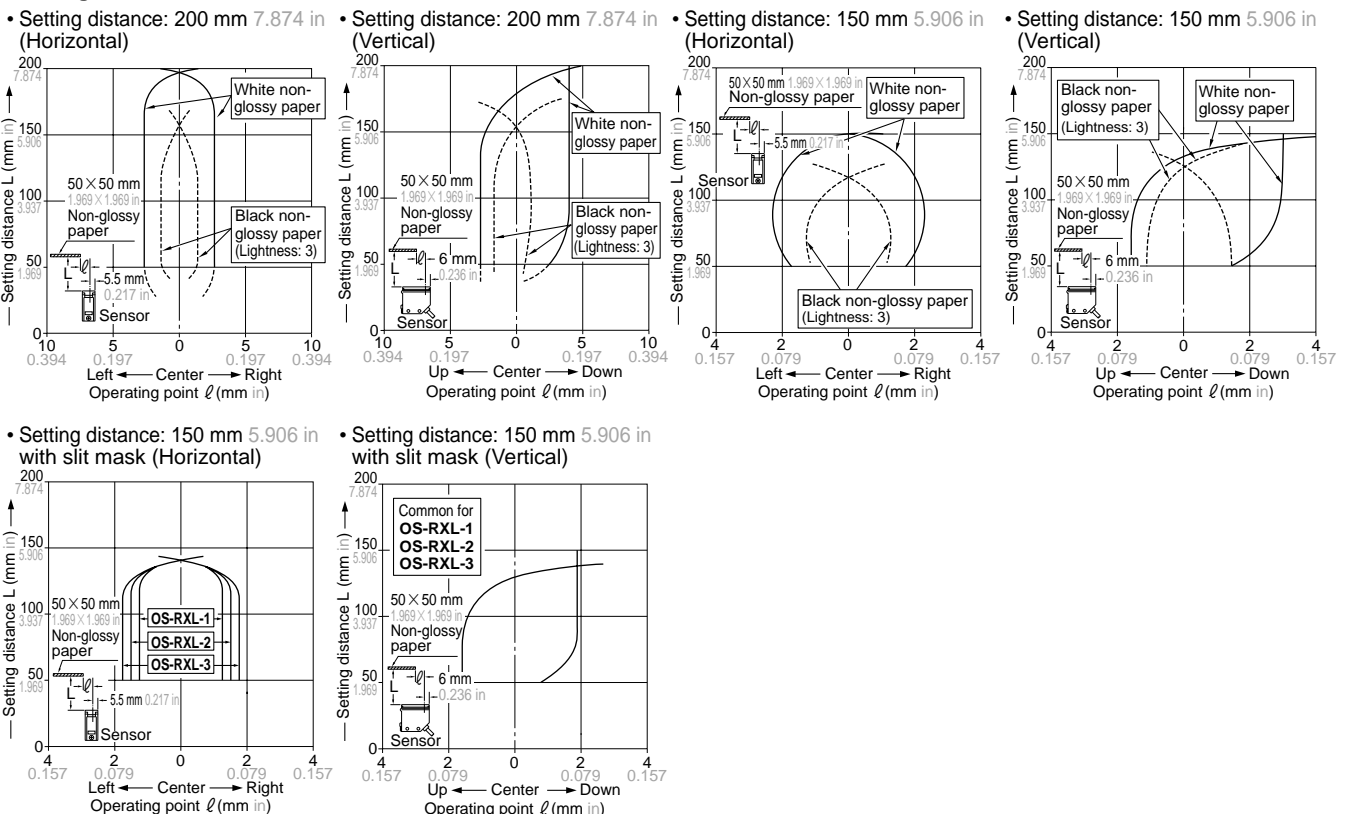

RX-LS200

SENSING CHARACTERISTICS (TYPICAL)

Correlation between sensing object size and sensing range

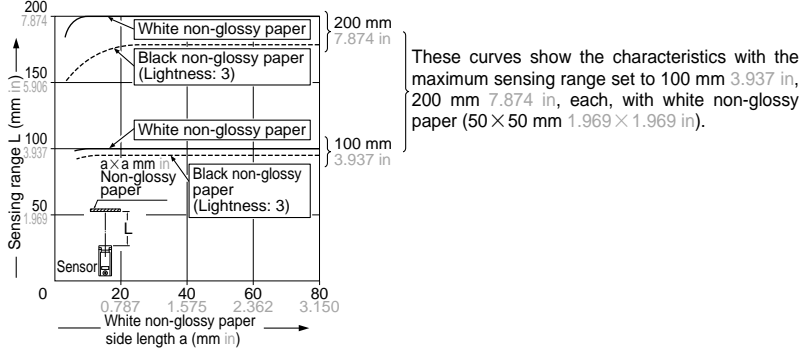

Emitting beam

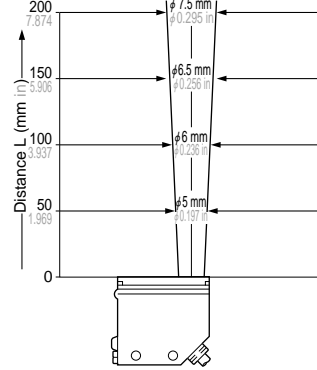

Correlation between material (50 × 50 mm 1.969 in × 1.969 in) and sensing range

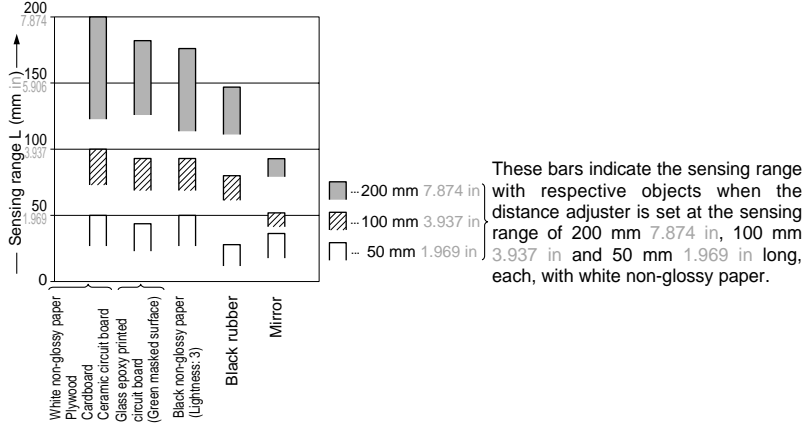

PRECAUTIONS FOR PROPER USE

Refer to p.1135~ for general precautions.



This product is not a safety sensor. Its use is not intended or designed to protect life and prevent body injury or property damage from dangerous parts of machinery. It is a normal object detection sensor.

Mounting

- The tightening torque should be 1.17 N·m or less.

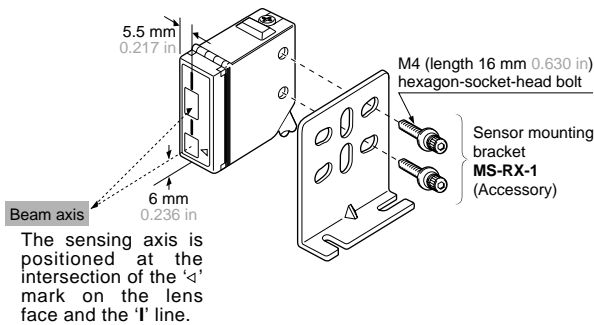

- Care must be taken regarding the sensor mounting direction with respect to the object's direction of movement.

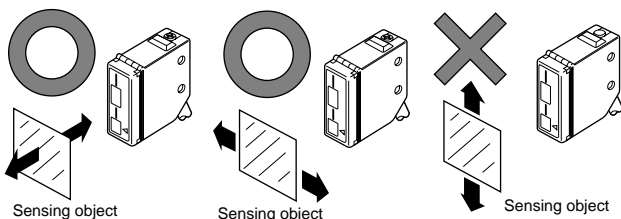

- When detecting a specular object (aluminum or copper foil) or an object having a glossy surface or coating, please take care that there are cases when the object may not be detected due to a small change in angle, wrinkles on the object surface, etc.
- When a specular body is present below the sensor, use the sensor by tilting it slightly upwards to avoid wrong operation.
- If a specular body is present in the background, wrong operation may be caused due to a small change in the angle of the background body. In that case, install the sensor at an inclination and confirm the operation with the actual sensing object.
- Do not install the sensor at a distance of less than 50 mm 1.969 in from the object because the sensing is unstable in this range.

Wiring

- The output of RX-LS200-P does not incorporate a short-circuit protection circuit. Do not connect it directly to a power supply or a capacitive load.

Others

- Do not use during the initial transient time (50 ms) after the power supply is switched on.

PRECAUTIONS FOR PROPER USE

Refer to p.1135~ for general precautions.

Distance adjustment <Adjusters>

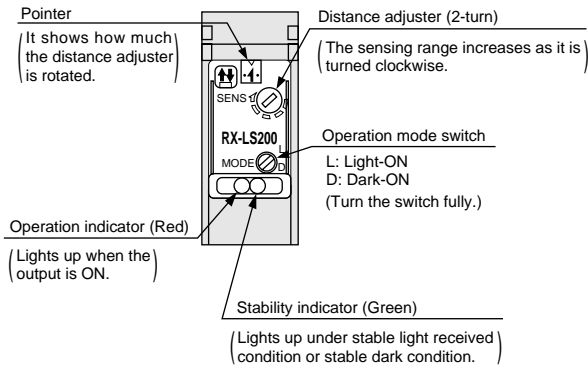

<Adjusting procedure>

Step	Description	Distance adjuster
①	Turn the distance adjuster fully counterclockwise to the minimum sensing range position (50 mm 1.969 in approx.). (Do not turn excessively.)	Turn
②	Place an object at the required distance from the sensor, turn the distance adjuster gradually clockwise, and find out point 'A' where the sensor changes to the light received condition.	
③	Remove the object, turn the distance adjuster further clockwise, and find out point 'B' where the sensor changes to the light received condition again with only the background. (When the sensor does not go to the light received condition even if the adjuster is fully turned clockwise, point 'B' is this extreme point.)	
④	The optimum position to stably detect objects is the center point between 'A' and 'B'.	Optimum position

DIMENSIONS (Unit: mm in) The CAD data in the dimensions can be downloaded from the SUNX website: <http://www.sunx.co.jp/>

RX-LS200 RX-LS200-P Sensor

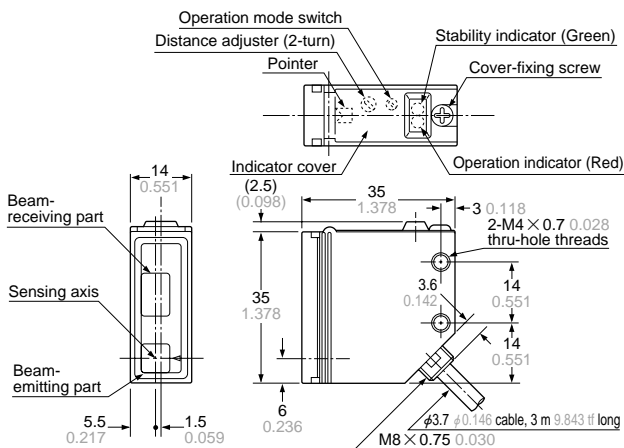

PT-RX500 PT-RX1000 Protective tube (Optional)

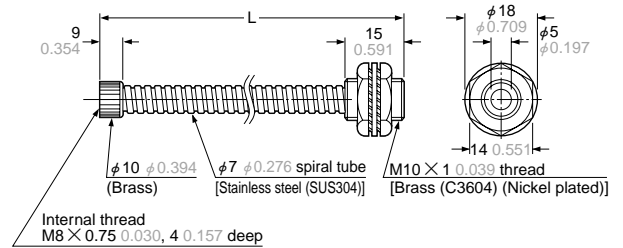

· Length L

Model No.	L (mm in)
PT-RX500	500 ⁺¹⁰ ₀ 19.685 + 0.394 0
PT-RX1000	1,000 ⁺¹⁰ ₀ 39.370 + 0.394 0

MS-RX-1 Sensor mounting bracket (Accessory)

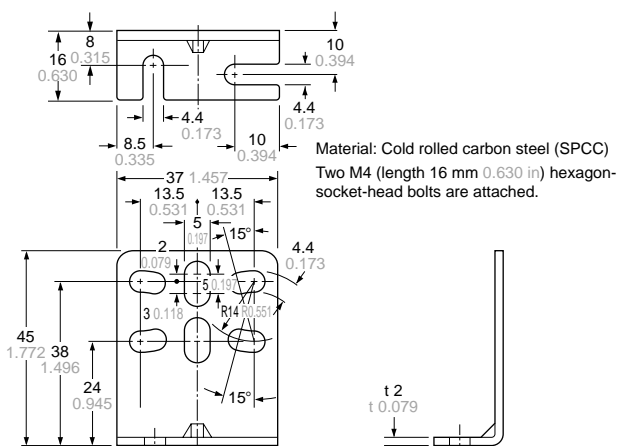

Assembly dimensions

